

3 YEAR WARRANTY

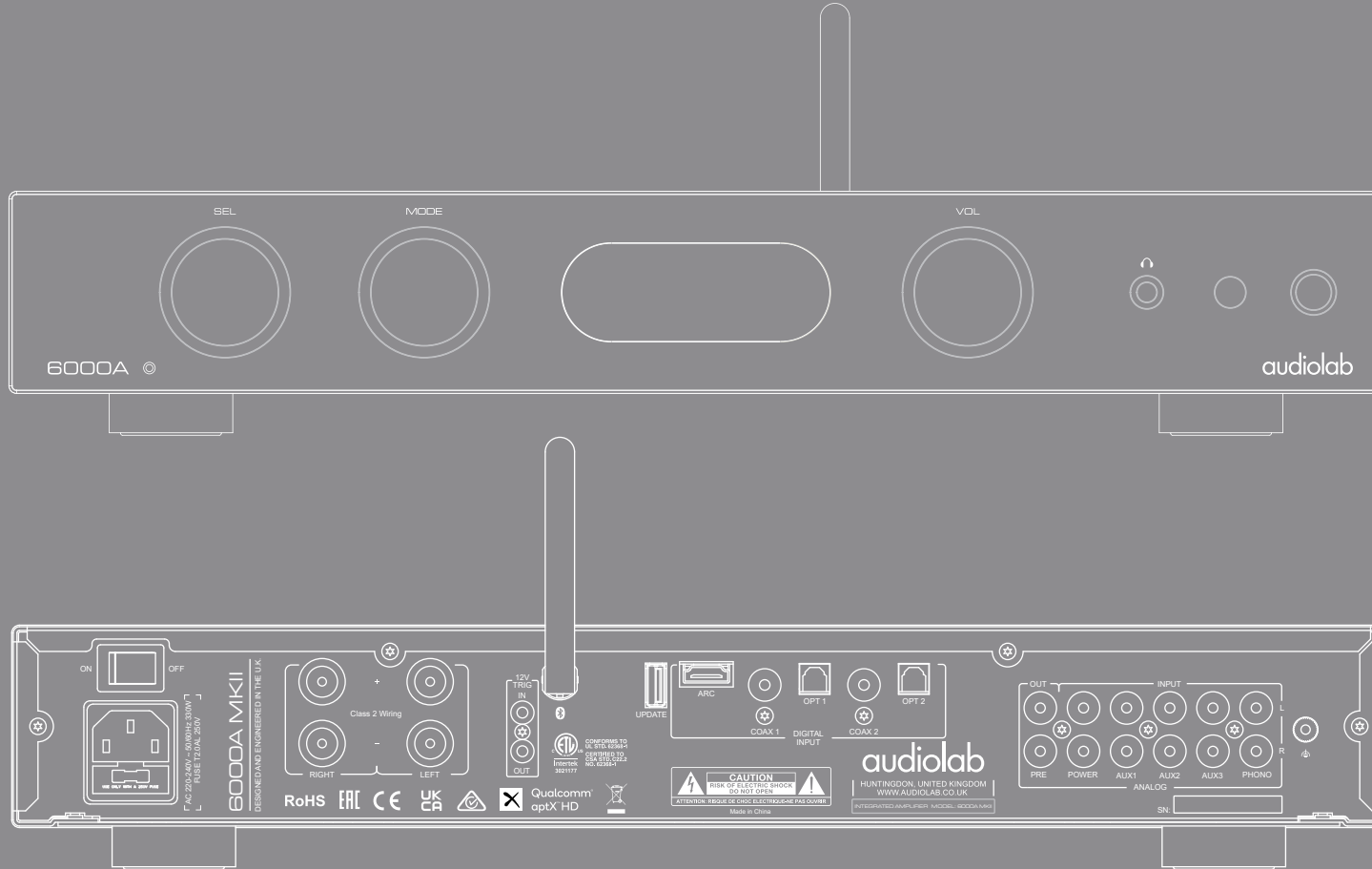

Scan the QR code using a smart-phone device, for product warranty registration online.

audiolab



6000A MKII

User Manual

Important Safety Information



This lightning flash with an arrowhead symbol within an equilateral triangle is intended to alert the user to the presence of non-insulated "dangerous voltage" within the product's enclosure that may be of sufficient magnitude to constitute a risk of electric shock.

Warning: To reduce the risk of electric shock, do not remove the cover (or back) as there are no user-serviceable parts inside. Refer servicing to qualified personnel. The exclamation point within an equilateral triangle is intended to alert the user to the presence of important operating and maintenance instructions in the literature accompanying the appliance.

Read these instructions.

Keep these instructions.

Heed all warnings.

Follow all instructions.

Do not use this apparatus near water.

Clean only with a dry cloth.

Do not block any ventilation openings. Install under the manufacturer's instructions. Do not install near any heat sources such as radiators, heat registers, stoves, or other apparatus (including amplifiers) that produce heat.

Do not defeat the safety purpose of the polarized or grounding-type plug. A polarized plug has two blades with one wider than the other. A grounding plug has two blades and a third grounding prong. The wide blade or the third prong is provided for your safety. If the provided plug does not fit into your outlet, consult an electrician for the replacement of the obsolete outlet.

Protect the power cord from being stepped on or pinched, particularly at the plugs, convenience receptacles, and at the point where they exit from the apparatus. Unplug this apparatus during lightning storms or when unused for long periods.

Refer all servicing to qualified service personnel. Servicing is required when the apparatus has been damaged in any way, such as power supply cord or plug is damaged, liquid has been spilled or objects have fallen into the apparatus, the

apparatus has been exposed to rain or moisture, does not operate normally, or has been dropped.

CAUTION: These servicing instructions are for use by qualified service personnel only. To reduce the risk of electric shock, do not perform any servicing other than that contained in the operating instructions unless you are qualified to do so. Do not install this equipment in a confined or built-in space such as a bookcase or similar unit, and keep well ventilated in an open space. The ventilation should not be impeded by covering the ventilation openings with items such as newspaper, tablecloths, curtains etc.

WARNING: Only use attachments/accessories specified or provided by the manufacturer (such as the exclusive supply adapter, battery etc).

WARNING: Please refer to the information on the exterior panel of the enclosure for electrical and safety information before installing or operating the apparatus.

WARNING: To reduce the risk of fire or electric shock, do not expose this apparatus to rain or moisture. The apparatus shall not be exposed to dripping or splashing and objects filled with liquids, such as vases, shall not be placed on the apparatus.

WARNING: For the terminals marked with the symbol  " " may be of sufficient magnitude to constitute a risk of electric shock. The external wiring connected to the terminals requires installation by an instructed person or the use of ready-made leads or cords.



Ground protection terminal. This product should be connected to a power outlet with ground protection.

Denmark: Apparatets stikprop skal tilsluttes en stikkontakt med jord, som giver forbindelse til stikproppens jord.

Finland: Laite on liitettävä suojakoskettimilla varustettuun pistorasiaan.

Norway: Apparatet må tilkoples jordet stikkontakt.

Sweden: Apparaten skall anslutas till jordat uttag.

WARNING: No naked flame sources, such as lighted candles, should be placed on the apparatus.

WARNING: Attention should be drawn to the environmental aspects of battery disposal.

WARNING: Use of the apparatus in tropical climates.

THE FUSE VALUES ARE: 220 - 240V (UK, China, etc.) T2.0AL 250V Slow Blow
100 - 120V (USA, Japan, etc.) T4.0AL 250V Slow Blow

Important Safety Information

FCC Statement

This equipment has been tested and found to comply with the limits for a Class B digital device, pursuant to part 15 of the FCC Rules. These limits are designed to provide reasonable protection against harmful interference in a residential installation. This equipment generates, uses and can radiate radio frequency energy and, if not installed and used in accordance with the instructions, may cause harmful interference to radio communications.

However, there is no guarantee that interference will not occur in a particular installation. If this equipment does cause harmful interference to radio or television reception, which can be determined by turning the equipment off and on, the user is encouraged to try to correct the interference by one or more of the following measures:

- Reorient or relocate the receiving antenna.
- Increase the separation between the equipment and receiver.
- Connect the equipment into an outlet on a circuit different from that to which the receiver is connected.
- Consult the dealer or an experienced radio/TV technician for help.

Caution: Any changes or modifications to this device not explicitly approved by the manufacturer could void your authority to operate this equipment. This device complies with part 15 of the FCC Rules. Operation is subject to the following two conditions:

- (1) This device may not cause harmful interference, and
- (2) This device must accept any interference received, including interference that may cause undesired operations.

RF Exposure Information

- The device has been evaluated to meet general RF exposure requirements.
- The device can be used in portable exposure condition and compliance with exposure requirements.

ISED Statement

This device contains license-exempt transmitter (s) / receiver (s) that comply with Innovation, Science and Economic Development Canada's licence-exempt RSS (s). Operation is subject to the following two conditions:

- (1) This device may not cause interference.
- (2) This device must accept any interference, including interference that may cause undesired operation of the device.

The digital apparatus complies with Canadian CAN ICES-3 (B) / NMB-3 (B).

This device meets the exemption from the routine evaluation limits in section 2.5 of RSS 102 and compliance with RSS 102 RF exposure, users can obtain Canadian information on RF exposure and compliance.

This equipment complies with Canada's radiation exposure limits set forth for an uncontrolled environment.

The device has been evaluated to meet general RF exposure requirements.

This equipment should be installed and operated with a minimum distance of 0mm between the radiator & your body.



The Bluetooth® word mark and logos are registered trademarks, owned by Bluetooth SIG, Inc. and any use of such marks by IAG Group Ltd is under license. Other trademarks and trade names are those of their respective owners.



Qualcomm is a trademark of Qualcomm Incorporated, registered in the United States and other countries. aptX is a trademark of Qualcomm Technologies International, Ltd., registered in the United States and other countries.

1 : Getting Started

Page 04

Welcome to Audiolab 6000 Series.

6000A MKII is the latest in a long line of Audiolab integrated amplifiers with a pedigree that stretches back to the very first 8000A that made Audiolab an overnight sensation.

The 6000A MKII features analogue and digital audio circuitry of the highest quality and has been designed by engineers who are passionate about the reproduction of music, and we hope you will enjoy its performance for many years to come.

Please read through this manual to obtain the very best performance from your 6000A MKII.

Features:

- Bluetooth aptX/aptX HD
- DAC-ES9038Q2M
- Dedicated high performance MM Phono Input
- Separate Pre-Power sections for flexibility of operation
- Automatic equipment activation via 12V trigger
- Auto standby function

Inputs:

- Three unbalanced analogue input pairs (AUX1, 2, 3)
- One Phono input (MM)
- One Power-Amp input
- Two Coaxial SPDIF digital inputs
- Two Optical SPDIF digital inputs
- Bluetooth 5.1 (aptX / aptX HD) input
- One HDMI ARC input
- One 12V Trigger input

Outputs:

- Pre-Amplifier output
- Loudspeaker output
- Headphone output
- 12V trigger output

Unpacking

Unpack the product fully. The carton should contain:

- The Audiolab 6000A MKII
- One IEC power cord suitable for your area
- One Remote handset
- This instruction manual
- 2 x AAA batteries

If an item is missing or damaged report this to your dealer as soon as possible.

Retain the packing for safe transport of your unit. If you dispose of the packing, do so with regard to any recycling regulation in your area.

Placement

The unit is designed to run warm during normal operation but ensure you do not block any ventilation openings.

Place the unit on a sturdy shelf or table. If you use an equipment rack, ensure the unit has adequate ventilation and is on its own shelf.

Check your mains voltage corresponds to the rating printed on the rear panel (near the power inlet socket).

If in doubt, consult your dealer. If you move to an area with a different mains voltage seek advice from an Audiolab appointed dealer or a competent service technician.

2: Controls and Connectors Page 05

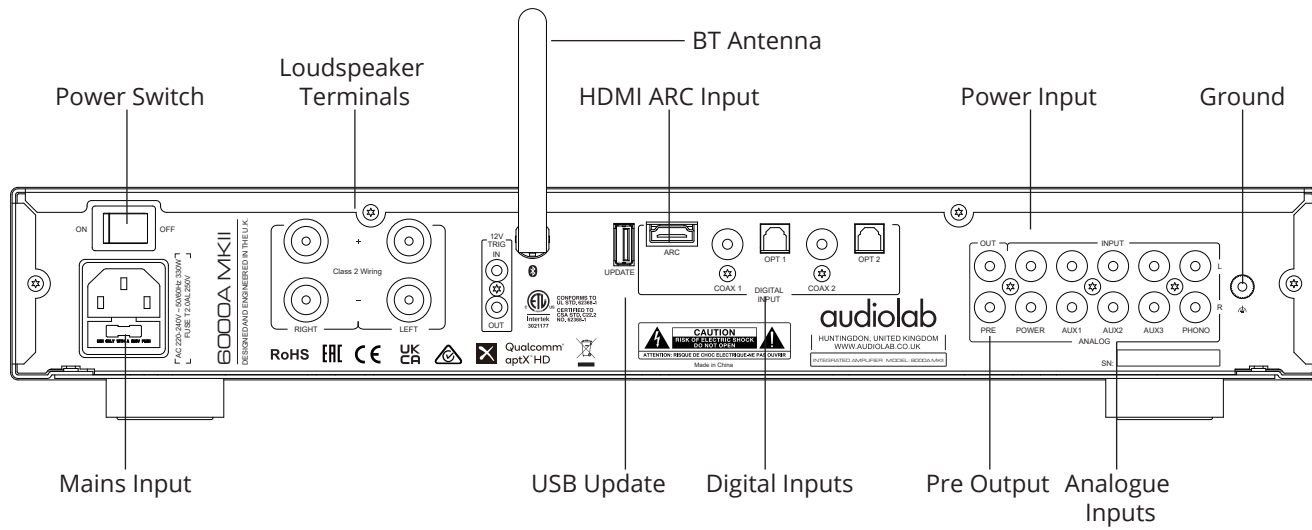
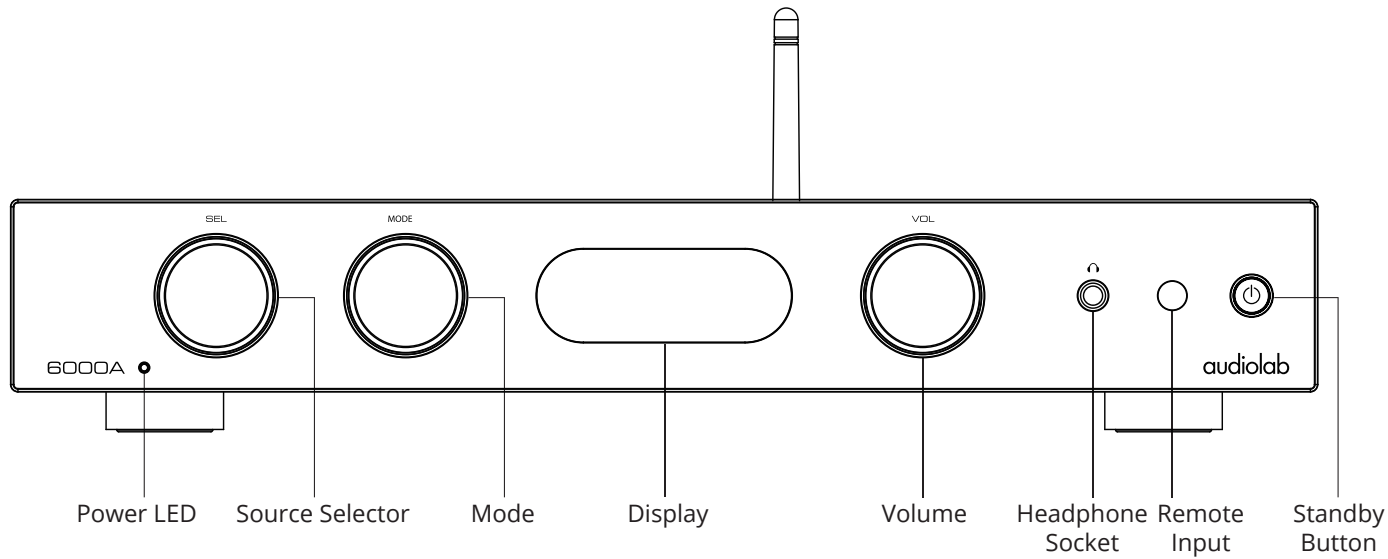

3: Remote Handset

NOTE : the handset buttons shown crossed out are for use with other Audiolab units like Audiolab 6000CDT and are not operational when used with the 6000A MKII

Page 06

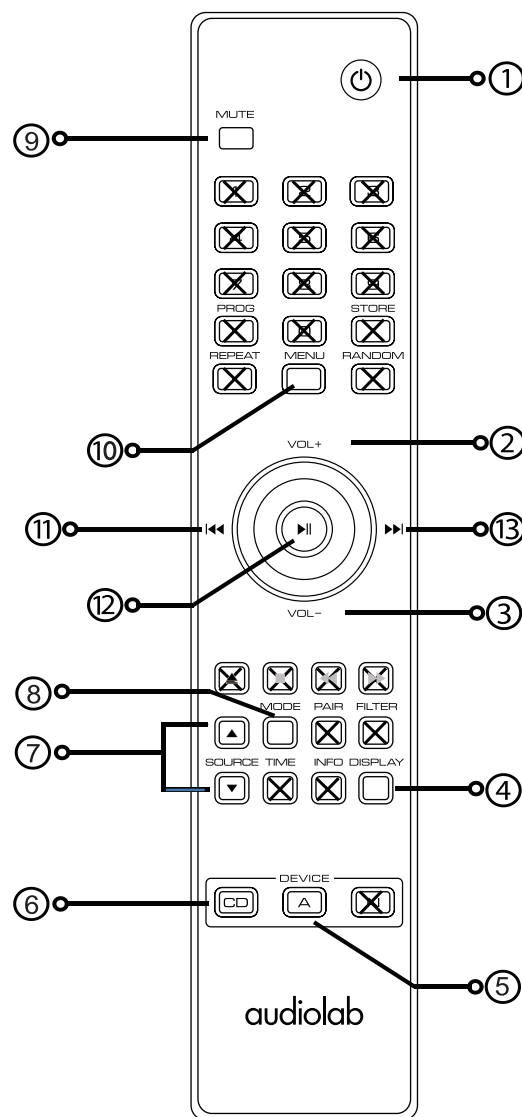

- | | | |
|----|---------|--|
| 1 | STANDBY | Press to bring the unit in/out of Standby |
| 2 | VOL+ | Increase Volume |
| 3 | VOL- | Decrease Volume |
| 4 | DISPLAY | Press to toggle the display on/off |
| 5 | A | Press to select 6000A MKII remote mode |
| 6 | CD | Press to select 6000CDT remote mode |
| 7 | SOURCE | Press to cycle source inputs |
| 8 | MODE | Press to select 6000A MKII operating mode |
| 9 | MUTE | Press to mute and unmute the sound |
| 10 | MENU | Press to enter MENU |
| 11 | ◀◀ | Press once to replay the current track of BT
Move to previous page or setting in menu |
| 12 | ⏮ | Press to start / pause BT playback
Press to confirm page or setting selected in menu |
| 13 | ▶▶ | Move to the next track of BT
Move to next page or setting in menu |

Fitting Batteries

Open the battery compartment cover, unwrap the supplied AAA batteries and place them in the battery compartment with the correct polarity. Replace the cover.

Always use AAA batteries and replace them in sets - never mix old and new batteries.

Very weak batteries can leak and damage the handset. Replace them in good time!

Note: there is a risk of fire and burns if a battery is handled improperly.

Do not disassemble, crush, puncture, short the contacts or dispose of the batteries in fire or water.

Do not attempt to open or service a battery.

Discard used batteries in full accordance with recycling regulations in force in your area.

Handset Operation

The handset operates several Audiolab components.

The handset buttons shown crossed out are for use with other Audiolab units and are not operational when used with the 6000A MKII.

Point the handset at the remote receiver and press the relevant key. The handset should be within 15 meters of the player and there must be a clear line of sight between the two units.

4: Connections - 1

Page 07

Analogue Inputs (Line Level)

Connect your analogue sources to one of the three line level inputs, AUX1, AUX2 or AUX3.

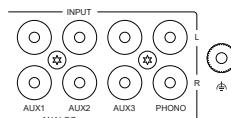

Phono Input (MM)

Connect your Turntable (Moving Magnet cartridge) to the PHONO Input. Connect the Earth lead from your Turntable (if available) to the GROUND terminal.

Coaxial Digital Inputs

Connect your coaxial digital sources to either COAX1 or COAX2.

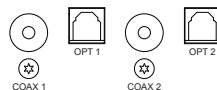

Optical Digital Inputs

Connect your Optical digital sources to either OPT1 or OPT2.

ARC Digital Input

ARC function allows you to send audio from your ARC-compliant TV to 6000A MKII through a single HDMI connection. To enjoy the ARC function, please ensure your TV is both HDMI-CEC and ARC compliant and set up accordingly.

Please note: Your TV must support the HDMI-CEC and ARC functions.

HDMI-CEC and ARC must be set to on. Please make sure that your TV's HDMI ARC Audio output is set to PCM Stereo or PCM 2-channel*. The configuration method of HDMI-CEC and ARC differ depending on the brand or model of your TV. For details about the ARC function, please refer to your TV owner's manual.

Please make sure that you are using a HDMI 1.4 cable or higher to support the HDMI ARC functionality.

*exact naming may vary depending on your TV.

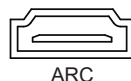

Bluetooth Connection

Select BT source on the 6000A MKII, on your mobile device search for 'Audiolab 6000A MKII BT' and connect.

Once paired the front panel SOURCE indicator will be turned on. If you switch to another input on the 6000A MKII your mobile device will be disconnected after 60 sec. To reconnect, select BT on the 6000A MKII and it will connect to the last paired device, or select 'Audiolab 6000A MKII BT' on your mobile device in the Bluetooth menu and it will reconnect.

Long pressing the pause/play button on the remote control will disconnect the bluetooth connection between your transmitting device, and the 6000A MKII.



Pre-Amplifier Output

Pre-amplifier output for driving external power amplifiers, subwoofers or signal processors.



Loudspeaker Terminals

One set of Loudspeaker output terminals.

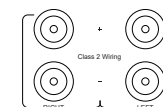

Headphone Output

A stereo 6.3mm (1/4") jack is provided on the front panel for connecting Headphones.

When Headphones are connected the audio to the loudspeakers terminals will be cut off.



4: Connections - 2

Page 08

USB Update

Any official Audiolab update will be provided by download from audiolab.co.uk

Please read and follow any instructions provided with any such download.

POWER OFF the 6000A MKII unit. Insert the USB storage device, onto which the USB update files have been loaded. Press the STANDBY button on the front panel then simultaneously POWER ON, your 6000A MKII will upgrade automatically.

Wait for the device display to confirm that the update is completed. Then, unplug the USB drive and restart the 6000A MKII. The unit is now ready to use.

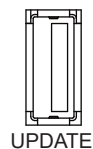

Mains Input

Before connecting the 6000A MKII to the mains supply make sure all other connections to your system have been properly and securely made.

Make sure the ON/OFF switch on the rear of the unit is switched off.

Now connect the supplied mains cable to the AC supply outlet.

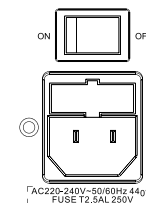

12V Trigger Connections

The 6000A MKII features two 12V Trigger connections, one output and one input. Use the output to control other products (ie. Audiolab amplifiers or 3rd party compatible equipment). Use the input when the 6000A MKII is to be controlled (ie. by Audiolab 6000CDT, or 3rd party compatible equipment).

The Trigger connections are made using 3.5mm to 3.5mm jack interconnects (not incl.).

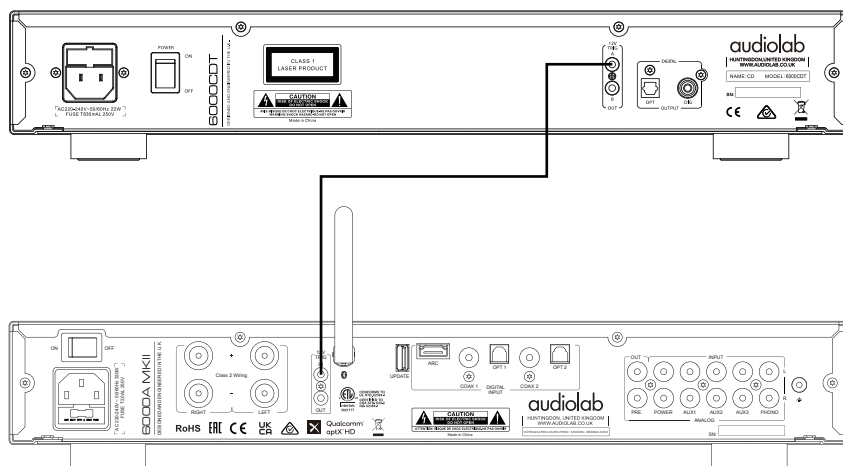

5: Operation - 1

Page 09

Switching On and Off

Switch on all source units before switching on power to the 6000A MKII.

When switching On: The power LED illuminates.

When switching Off: Switch off the 6000A MKII before the source units.

Standby Mode

The 6000A MKII will enter standby mode after being powered on. Press the "Standby" button to bring the 6000A MKII out of standby, the power indicator LED becomes brighter and the display shows "6000A MKII" welcome screen while the unit is getting ready for operation.

The Auto Standby feature will, by default, put the unit into standby after 20min of inactivity.

This feature can be configured using the MENU (see page 8) and be set to 20min, 1 hour or Never.

Source Select

Rotate the SEL knob on the front panel or use the source buttons on the remote handset to select different source inputs.

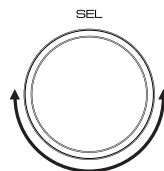

Volume Control

Rotate the VOL knob on the front panel, or use the Volume up/down keys on the remote control, to set the volume level. The range is -78dB to +8dB, the factory default volume setting is -20dB.

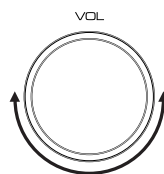

Power On (Limit)

Power On Limit sets the maximum volume level as the unit is switched on.

When coming out of standby, the volume setting will be set to the level that was used at the end of the previous operating session OR to the Power On Limit value set in this menu, whichever is lowest.

This will avoid a sudden loud signal at the beginning of a new session. Set to OFF to disable this function

Mute

Press the VOL knob on the front panel or the MUTE button on the remote handset to mute / un-mute the sound.

Display Setting

The DISPLAY button on the remote control will toggle the front panel display ON/OFF.

When the display is OFF: Using the front panel controls or pressing any remote key will momentarily turn on the display, after 5 sec. the display will go off.

Digital Filter Selection (DAC)

The DAC in the 6000A MKII has a choice of 5 digital filters, Press the MENU key on the remote control to access the FILTER options (see page 9 for further details) Configure the digital filter for the audio DAC. Linear Phase (Slow Roll-Off) is the default setting.

- L FAST: **Linear Phase (Fast Roll-Off)**

This is the most common filter with clean overall suppression and excellent rejection, best for music with large transients. Provides crisp clean highs.

- L SLOW: **Linear Phase (Slow Roll-Off)**

A low group delay and symmetrical input response with less ringing than 'Linear-phase fast roll-off'. It offers punchier bass than 'Linear-phase fast roll-off', with clean highs. (Default)

- M FAST: **Minimum Phase (Fast Roll-Off)**

This offers minimal pre-ringing. It is usually preferred for imaging and sound stages. It offers no aliasing in the frequency domain and stronger bass than 'Linear Phase', with clean highs.

- M SLOW: **Minimum Phase (Slow Roll-Off)**

A Non-Symmetrical filter designed to minimise pre-ringing. It offers a strong punchy bass with a good transient attack.

- H FAST: **Hybrid (Fast Roll-Off)**

This is the combination of 'Linear-phase' and 'Minimum-phase'. It offers a fast transient attack, strong punchy bass and crisp highs.

5: Operation - 2 Page 10

Operating Modes

Although the 6000A MKII is an integrated amplifier it can function as a separate Pre and Power amplifier.

Use the MODE knob on the front panel, or the MODE key on the Remote control, to select different operating modes.

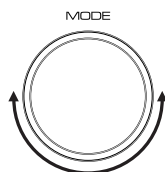

MODE	POWER AMP IN	PRE OUT	HEADPHONE OUT	LOUDSPEAKERS
PRE	DISABLE	ACTIVE	ACTIVE	DISABLE
PRE-POWER	ACTIVE	ACTIVE	ACTIVE	ACTIVE
INTEGRATED	DISABLE	ACTIVE	ACTIVE	ACTIVE

Pre-Power Mode

The preamplifier section is internally disconnected from the power amplifier. The 6000A MKII can be used as a stand-alone power amplifier (ie. part of an AV setup). This mode can also be used if additional signal processing is required, connecting the pre-out to an external signal processor and then taking the output from the processor to the 6000A MKII Power-IN.

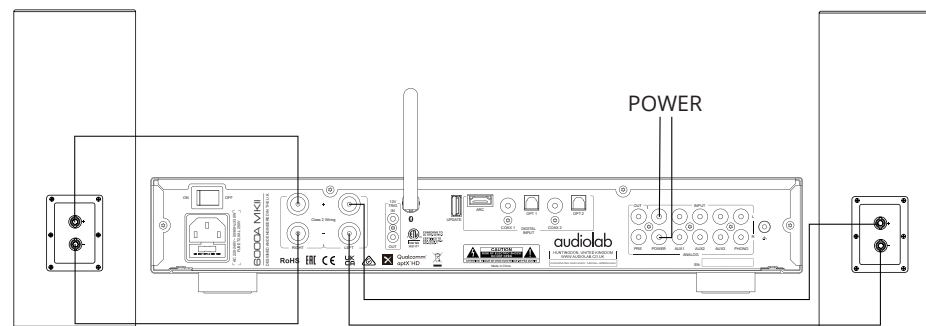

Integrated Mode

The pre-amplifier section is internally connected to the power amplifier, Pre-amplifier output is also operational in this mode. A second power amplifier can be connected for bi-amplification, as shown in the diagram.

Pre Mode

All signals to and from the power amplifier of the 6000A MKII are disconnected. In this mode, the 6000A MKII functions as a stand-alone pre-amplifier. The pre-amplifier section of the 6000A MKII can be connected to a stereo power amplifier, or to two mono-block amplifiers.

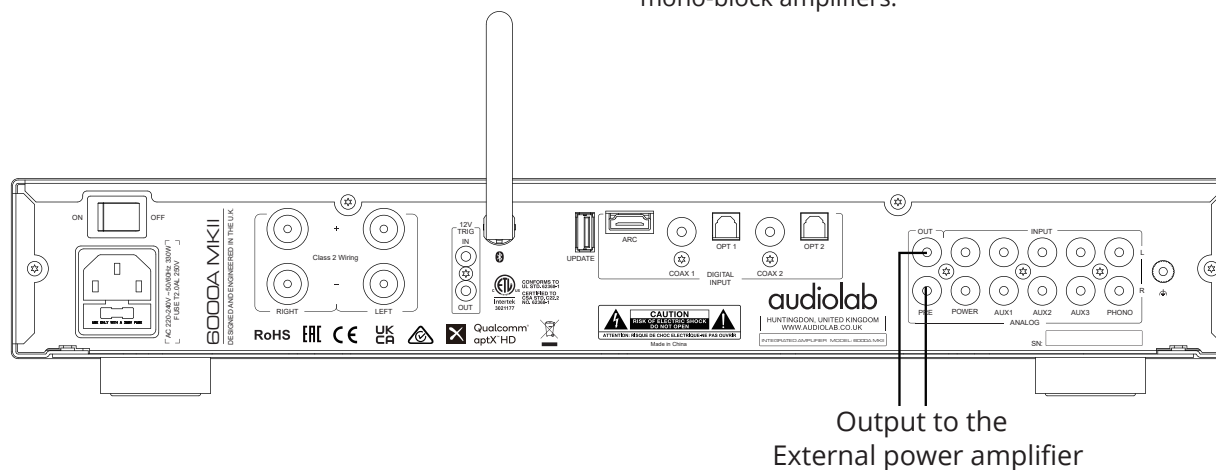

5: Operation - 3

The MENU

The Menu enables you to customise the unit and optimise the interface with other equipment in your system.

6000A MKII has 11 different menu pages. Press the MENU key on the remote control to enter the menu mode. Press **◀◀** or **▶▶** to cycle through menu pages. Press **▶** to enter menu options and confirm option selections. The menu can also be accessed via the MODE knob on the front panel. Rotate the MODE knob to cycle menu options. Press the MODE knob to enter menu options and confirm option selection.

The device will exit the menu mode after 5 seconds of no operation.

The Menu Tree

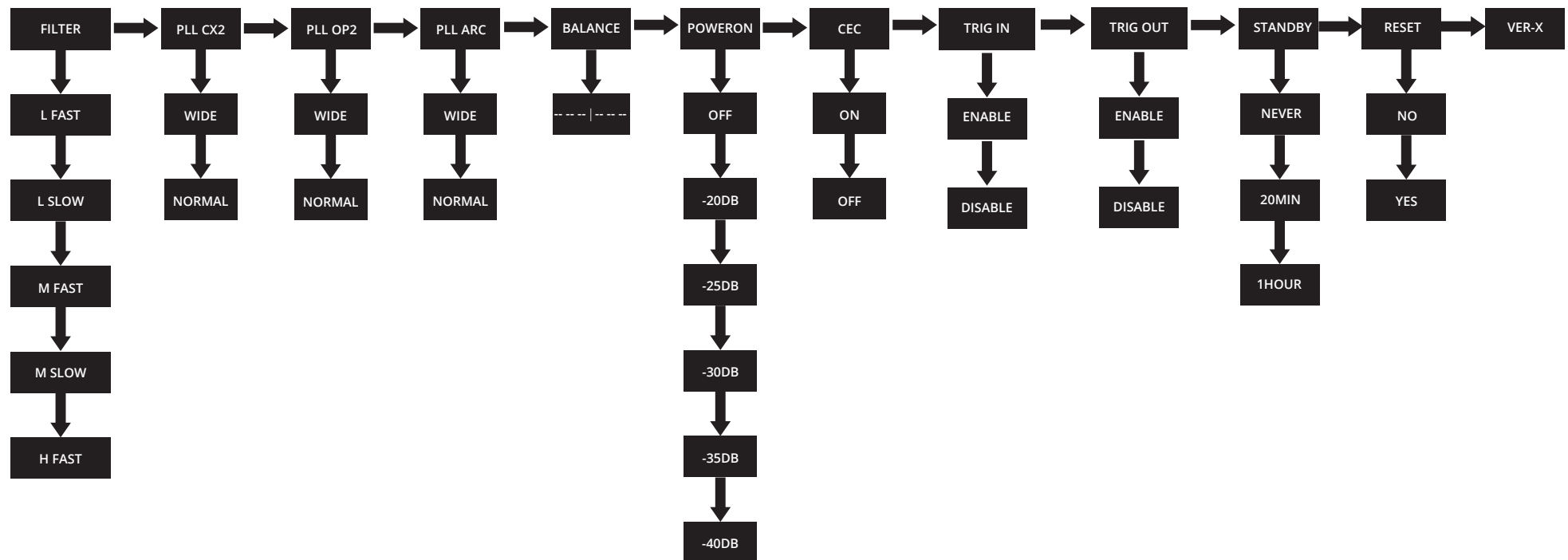

6: Warranty Coverage - 1

Page 12

Audiolab warrants this product, subject to the terms and conditions below, to be free from defects in materials and workmanship. During the warranty period Audiolab will repair or replace (at Audiolab's option) this product, or any defective part in this product, if it is found to be defective due to faulty materials, workmanship or function. The warranty period may vary from country to country.

Online Registration



Scan the QR code using a smart-phone device, for product warranty registration online.

The three (3) year extended warranty is applicable to items purchased from Jan 1st 2021, onwards. Items purchased prior to this date are not eligible for this extended warranty service but are subject to statutory warranty claims and all applicable consumer rights.

To qualify for the extended 3 year warranty, you must register your product within ninety (90) calendar days from the date of purchase.

Visit audiolab.co.uk/warranty-registration to complete your online registration. Items not registered online will have a Limited Warranty for one (1) year, or for the period of your country's statutory warranty, whichever is longer.

Warranty can only be offered to products registered with proof of purchase with date, model and details of the authorised dealer clearly stated on the receipt/invoice. Please keep the original receipt/invoice in case it is required for a warranty claim.

This Limited Warranty is non-transferable and is offered exclusively to the original owner.

This Limited Warranty is valid only in the original country of purchase.

Repairs or replacements are provided under this warranty are the exclusive remedy of the consumer. Audiolab shall not be liable for any incidental or consequential damages for breach of any expenses or implied warranty with any product. Except to the extent prohibited by law, this warranty is exclusive and in lieu of all other warranties whatsoever, both expressed and implied, including but not limited to the warrant of merchantability and fitness for practical purpose.

This warranty provides benefits that are additional to and do not affect your statutory consumer rights.

This Limited Warranty offer is subject to correct information being submitted in your application. Incorrect dates or mismatched purchase receipt dates that are outside of the warranty terms will immediately invalidate any warranty claim.

*Please check with your dealer local distributor for further information.

Exclusions

The following items are excluded from the Audiolab warranty:

Normal wear and tear and cosmetic damage (including but not limited to any wear from reasonable use, environmental deterioration or neglect)

Products on which the serial number has been removed, altered or otherwise made illegible.

Products not purchased from an authorised Audiolab dealer.

Products that were not new at the time of original purchase.

Products sold 'as is', 'as seen' or 'with faults'

Product not purchased from an Authorised Dealer/Distributor within the region of the claim (ie parallel imports or grey market products)

Accidental damage or faults caused by commercial use, acts of God, incorrect installation, incorrect connection, incorrect packaging, misuse or careless operation or handling which is not in accordance with the user instructions.

Equipment that has been operated in conjunction with unsuitable, inappropriate or faulty apparatus.

Repairs, alterations or modifications carried out by parties other than Audiolab or its authorised service partners.

Damage in transit that cannot be attributable to the fault of Audiolab, the authorised distributor or dealer (ie. claims otherwise covered by transit insurance.)

Faults relating to abnormal or inappropriate power supply voltage or power surges.

Faults relating to extremities in temperature, exposure to heat, water or other liquids, insects, excessive moisture, sand, chemicals, battery leakage or any other contaminants.

6: Warranty Coverage - 2

Page 13

Any force majeure events, including but not limited to any acts of God, fire, lightning, typhoon, storm, earthquake, hurricane, natural disaster, tsunami, flood, war, riot, public disturbance.

Any other causes beyond the reasonable control of either Audiolab and its Authorised Distributor.

Please note items purchased before 1st Jan 2021 are not eligible for the extended warranty claim.

How to Claim

To obtain warranty service please contact the authorised dealer from which you purchased this product and present the limited warranty certificate offered upon registration of your product's extended warranty offer.

Do not dispatch goods without the prior agreement of the dealer distributor or authorised service centre.

If asked to return products for inspection and or repair, please pack carefully preferably in the original carton or packaging affording an equal degree of protection and returned via insured, trackable courier service.

The authorised dealer or distributor will offer full return details and instructions. However, please note if unsuitable packaging is used the warranty may be deemed void due to improper action in return.

Audiolab or the authorised distributor, dealer or service centre may make a charge for the supply of new packaging for the return of the repaired item. Please note, insurance is recommended as goods are returned at the owner's risk. Authorised distributors or service centres cannot be held liable for loss or damage in transit. Insurance and freight charges on the return journey will be paid for by Audiolab, authorised dealer, distributor or service centre if corrective work proves to be necessary.

In the event of 'no-fault found' or 'no repair necessary', the return shipping charge will be the responsibility of the owner.

Repairs

All repairs will be carried out by the appointed distributor (or locally appointed service centre). Repairs handled or processed without authorisation or approval of the appointed representative will be excluded from this limited warranty. Please

note, Audiolab is not able to supply parts or replacement items to any other entity than the official distributor or authorised service centre.

Other than the warranty and services set out in this warranty, to the fullest extent permitted by law, Audiolab shall not be liable to you and/or any third party or entity whatsoever for:

- Any loss, damages and/or malfunction caused to any product(s) which is/are connected to any of the products covered by this warranty.
- Any damages, loss and liability, whether direct, indirect, incidental, consequential special, punitive or otherwise, howsoever caused by, arising out of or otherwise, in relation to the installation, delivery, use, service, repair, replacement and/or maintenance of the product;
- Any damages, loss and liability under this warranty in respect of any act, omission, or negligence of any of their technicians, employees, agents, representatives or independent contractors relating to the actual or purported performance of any of the obligations under this warranty.

Service Centre Address

Should a fault occur with your product, please pack it correctly using the original packing, so you can ship it safely. For technical support, servicing or product queries and information, please contact either your local retailer or the office below:

IAG Service Dept.
13/14 Glebe Road
Huntingdon
Cambridgeshire
PE29 7DL
UK

Tel: +44(0)1480 452561
Email: info@audiolab.co.uk

For information on other authorised service centres worldwide contact your local distributor.

A list of global distributors is available on the Audiolab website: www.audiolab.co.uk

7: Specifications - 1

Page 14

Model	6000A MKII
General Description	Integrated Amplifier
Design Philosophy and Core Technology	2x50W (8 ohms) / 2x75 (4 ohms) Class AB Design ES9038Q2M 32-bit DAC Bluetooth 5.1 (aptX / aptX HD) Dedicated High Performance Low Noise MM Phono stage Dedicated Current-Feedback Headphone Amp Integrated / Pre-Power / Pre Modes only Modes
Inputs	3 x Analogue, 1 x Phono (MM), 1 x Power Amplifier, 2 x SPDIF (Coax), 2 x SPDIF (Optical), 1 x HDMI ARC, 1 x Bluetooth (aptX / aptX HD), 1 x 12V Trigger
Outputs	1 x PRE Amplifier, 1 x Stereo Speaker, 1 x Headphone, 1 x 12V Trigger
Sampling Frequency	Optical / Coaxial: 44.1kHz-192kHz
Preamplifier Section	
Gain	+8dB (Line); +54dB (Phono MM)
Input Sensitivity	720mV (Line, Volume = 0dB); 3.1mV (Phone MM, Volume = 0dB)
Input Impedance	10K (Line); 47k/100pF (Phono MM)
Total Harmonic Distortion (THD)	<0.0004% (1kHz @ 2V, Volume = 0dB)
Frequency Response	20Hz-20kHz (+/-0.1dB)
Output Voltage	2.3V max. (Volume = 0dB)
Output Impedance	120 ohms
Signal-to-Noise Ratio	>110dB (Line, A-weighted); > 79dB (Phono MM, A-weighted)
DAC	
D to A Converter	ES9038Q2M
Total Harmonic Distortion (THD)	<0.001% (1KHz @ 0dBFS)
Output Level (0dBFS, 1kHz)	2.05Vrms

7: Specifications - 2

Page 15

Max. Sampling Frequency	Optical, Coaxial: 192kHz;
Signal-to-Noise Ratio (S/N)	>116dB (A-weighted)
Power Amplifier Section	
Gain	+29dB
Rated Power Output	2 x 50W (8 ohms, THD<1%); 2 x 75W (4 ohms, THD<1%)
Frequency Response	20Hz-20kHz (+/-0.3dB)
Total Harmonic Distortion (THD)	<0.003% (1kHz @ 50W / 8 ohms)
Input Sensitivity	720mV
Signal-to-Noise Ratio (S/N)	>109dB (A-weighted)
Max. Output Current	11A
Headphone Amplifier	
Total Harmonic Distortion (THD)	<0.01% (1kHz, 50mW)
Output Impedance	2.35 ohms
Load Impedance	20-600 ohms
General	
Standby Power Consumption	<0.5W
Net Weight	7.78kg
Gross Weight	9.7kg
Dimensions (mm) (W x D x H)	444 x 299 x 65
Carton Size (mm) (W x D x H)	510 x 465 x 155
Finish	Black / Silver
Power Requirements (depending on region)	220-240V - 50/60Hz 100-120V - 50/60Hz
Standard Accessories	Power Cord, Remote Control, User Manual, Antennas, 2 x AAA batteries.



Correct disposal of this product. This marking indicates that this product should not be disposed with other household wastes throughout the EU. To prevent possible harm to the environment or human health from uncontrolled waste disposal, recycle it responsibly to promote the sustainable reuse of material resources. To return your used device, please use the return and collection systems or contact the retailer where the product was purchased. They can take this product for environmental safe recycling.

Scan the QR code for latest user manuals and more.



